

# **2200 SURVEILLANCE**

**GASON AIRSEEDER MONITOR**

**INSTALLATION AND OPERATING**  
**INSTRUCTIONS**

**VERSION 2**

# CONTENTS

<b>1.0 INSTALLATION .....</b>	<b>3</b>
1.1 GENERAL OVERVIEW.....	3
1.2 MONITOR & CLUTCH BOX INSTALLATION .....	4
1.3 WIRING LOOM INSTALLATION.....	4
1.4 BATTERY CONNECTION .....	5
<b>2.0 OPERATION .....</b>	<b>6</b>
2.1 CLUTCH OPERATION.....	6
2.2 POWER ON / OFF KEY .....	6
2.3 IMPERIAL / METRIC KEY .....	6
2.4 RUN / HOLD KEY .....	7
2.5 SPEED KEY .....	7
2.6 TOTAL KEY .....	8
2.7 TRIP AREA KEY.....	9
2.8 TIMER KEY .....	10
2.9 FUNCTION KEY .....	11
2.10 TEST KEY .....	13
<b>3.0 CALIBRATION .....</b>	<b>14</b>
3.1 GENERAL INFORMATION.....	14
3.2 CALIBRATION WARNING.....	15
3.3 MEMORY BACK-UP .....	15
3.4 CALIBRATION SETTING.....	16
3.5 WHEEL CALIBRATION.....	18
<b>4.0 TROUBLESHOOTING .....</b>	<b>19</b>
<b>5.0 INTERFERENCE AND REMEDIES.....</b>	<b>23</b>
<b>6.0 SPECIFICATIONS .....</b>	<b>24</b>
<b>7.0 CONTACT DETAILS.....</b>	<b>24</b>
<b>GASON TRACTOR LOOM .....</b>	<b>25</b>
<b>GASON TRAILER LOOM 1880 (2 &amp; 3 BIN).....</b>	<b>26</b>
<b>GASON TRAILER LOOM 1880 (2 BIN).....</b>	<b>27</b>

# 1.0 INSTALLATION

## 1.1 GENERAL OVERVIEW

The FARMSCAN 2200 Surveillance Monitor V2.03 is designed to operate on Gason two bin and three bin airseeders.

Before operation make sure the correct Default setting is active when the unit is switched on. (See Section 3.1 for details)

All Airseeders are fully wired & tested with appropriate sensors to monitor Speed/Area, Fan Rpm, Air Pressure, Bin Levels, Metering Shaft Operation, & Material flow.

Main Clutch & Secondary Clutch (3 Bin Models) activation is by an independent Control Switch installed in the Tractor cab along with the two Monitoring units.

A separate Farmscan 1020 Airseeder Blockage Monitor provides Audible & Visual warning of failed material flow at the last Secondary Distributor head. This system can be easily expanded to monitor all Secondary Distributor Heads by adding on more Secondary Head Sensors available from any Farmscan or Gason Dealer.

Please follow Installation & Operation details to help ensure trouble free performance.

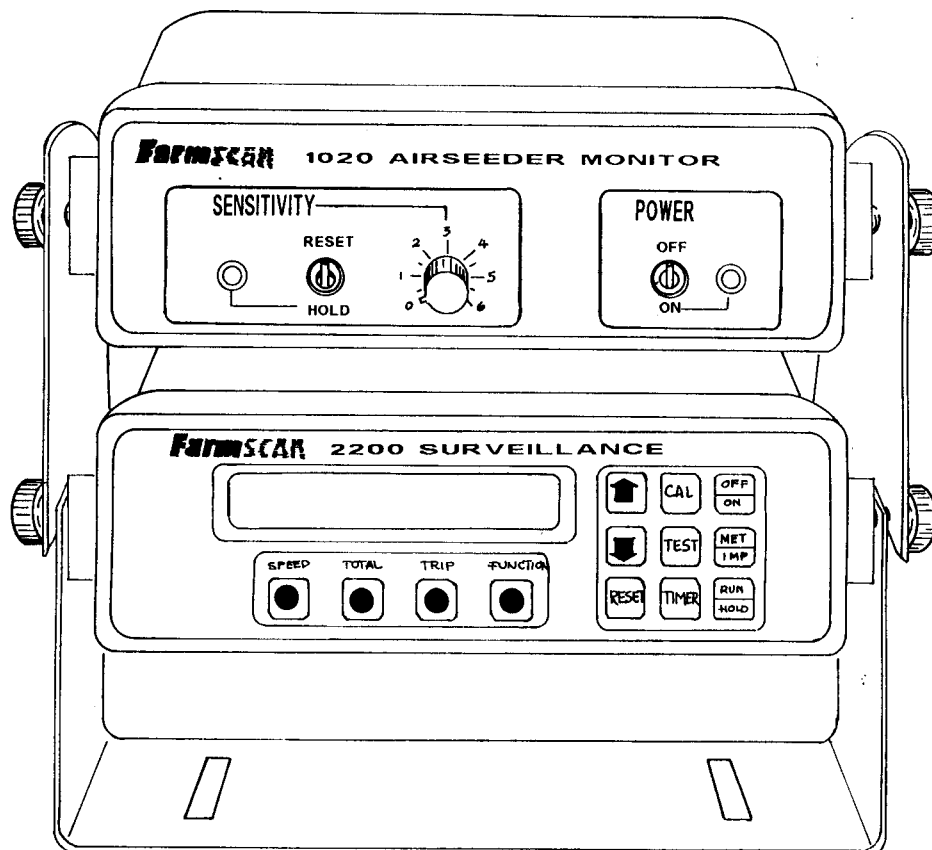

## 1.2 MONITOR & CLUTCH BOX INSTALLATION

The two monitor units should be installed in the cab, clearly visible to the operator but not subject to intense heat or moisture.

Keep the units away from radios or other electronic equipment to minimize any risk of interference. As a precaution all connection cables should take an alternative route to other cables in the cab; especially radio antennae cables.

Mount the units firmly on the bracket using securing knobs supplied.

The Clutch Control box needs to be mounted in a convenient position accessible to the operator and connected to the Tractor loom as shown.

The separate 8m Medium Duty power cable provided for the clutch must be run directly to the battery terminals.

**DO NOT CONNECT MONITOR POWER CABLES AND CLUTCH BOX POWER CABLES TOGETHER EXCEPT AT THE BATTERY TERMINALS.**

Secure the power cables away from risk of damage using the cable ties provided.

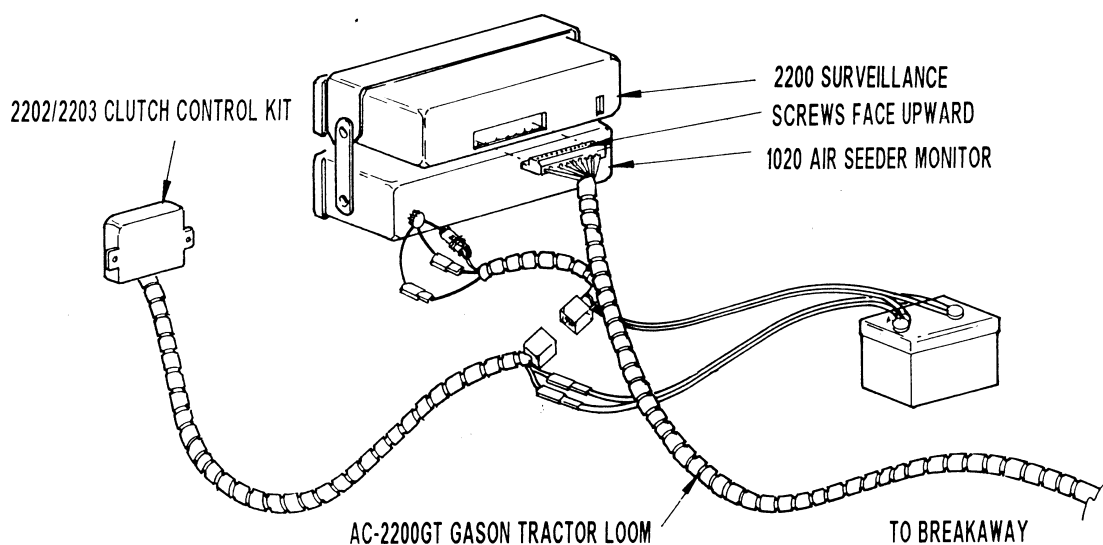

## 1.3 WIRING LOOM INSTALLATION

The Tractor Cable provided in the kit needs to be connected to the 2200 Surveillance Monitor, 1020 Airseeder Monitor and the Clutch Control kit.

Feed the cable from the Monitors through the cab and to the back of the Tractor where the Breakaway connection can be firmly secured in a breakout position away from hydraulic connectors.

Secure this cable away from risk of damage using the cable ties provided.

## 1.4 BATTERY CONNECTION

Do not connect battery power until all other installation is complete.

The 8 metre POWER CABLE must be connected DIRECT to 12 volt DC vehicle battery terminals.

**DO NOT** connect monitor to auxiliary power point on tractor or join monitor power cable together with Clutch Power Cable except at Battery Terminals.

**USE** cable ties supplied to secure power cable away from risk of damage.

Connection to battery terminals must be clean and tight.

**WARNING** -Disconnect Monitors from battery connection if arc welding on machinery.

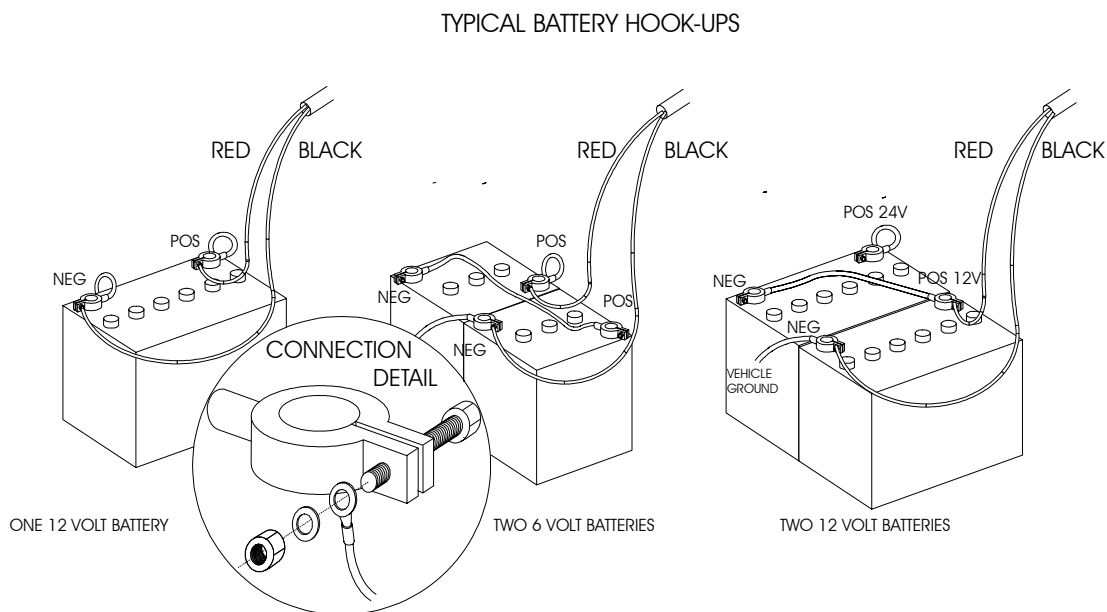

## 2.0 OPERATION

### 2.1 CLUTCH OPERATION

The Main Clutch & Secondary Clutch (if used) can be operated entirely independent of the monitors to Start & Stop machine operation.

When the Main Clutch is engaged, the monitors will go "OFF HOLD" to resume normal operation and will go "ON HOLD" to stop Alarms & Area recording when disengaged.

If the Hold function does not work refer to Run/Hold Calibration Instructions Page 18

### 2.2 POWER ON / OFF KEY

Whenever the SURVEILLANCE MONITOR is switched ON the display screen will show the following message.

e.g. 

This is immediately followed by the version number

e.g. 

The version number indicates which generation of functions and features are programmed into your unit.

If an upgraded programme is installed, a new version number e.g. VERSION 2.04 will be displayed.

The readout will always display the speed readout after switching on.

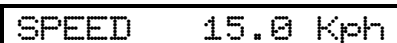
e.g. 

If any alarm points are active when the monitor is switched 'ON', press the RUN / HOLD key to silence the beeper.

### 2.3 IMPERIAL / METRIC KEY

Press the IMP / MET key to change any readout between METRIC and IMPERIAL equivalents.

e.g.  IMPERIAL IS UK IMPERIAL



**NOTE :** IMP / MET key is not active during calibration. These must be entered in metric values.

## 2.4 RUN / HOLD KEY

The RUN / HOLD key is generally not used, since Run/Hold is controlled by the main Clutch Operation.

The RUN / HOLD key can be used as an override to place the "Monitor On Hold" whilst the clutch is engaged. Press the RUN/HOLD key once to place the Monitor On Hold.

e.g 

Press RUN / HOLD again to place the MONITOR OFF HOLD

e.g 

When in HOLD mode, all alarms and accumulating readouts such as AREA, DISTANCE and the ELAPSED TIMER are stopped.

The monitor will repeat the 'Monitor On Hold' warning every 30 seconds to remind the operator everything is ON HOLD.

## 2.5 SPEED KEY

Press the SPEED key once to display ground speed

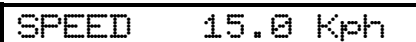
e.g 

Press the SPEED key again to display current work rate expressed as HECTARES PER HOUR.

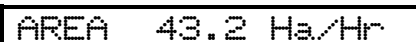
e.g 

## 2.6 TOTAL KEY

### **AREA TOTAL**

Press "TOTAL" key once to display TOTAL AREA worked.

e.g 

The area total can be reset at the start of sowing and left to accumulate daily to keep track of overall areas worked.

To reset AREA TOTAL press RESET key once to start reset process.

e.g 

Press "RESET" again to complete reset process or to abort reset process, press any other key to escape.

After reset of TOTAL you will have the option to reset all trip memories at the same time

e.g 

Press "RESET" again to reset all trips or to abort reset process, press any other key to escape.

### **DISTANCE TOTAL**

Press "TOTAL" key again to display TOTAL DISTANCE.

e.g 

To reset DISTANCE press "RESET" key once to start reset process.

e.g 

Press "RESET" again to complete reset process or to abort reset process, press any other key to escape.



## 2.7 TRIP AREA KEY

The TRIP AREA key allows the display of the sub total area for each separate plot of land worked as distinct from the LOAD AREA meter, which can be reset after every fill. The TRIP AREA function has 10 resetable memories to keep record of areas worked in different plots.

To display the current Trip Memory press TRIP AREA key.

e.g TRIP 1 56.2 Ha

Trip 1 may be used as a Load Area check and reset to zero at any time or kept as a record by changing to Trip 2, as explained below.

To reset Trip Memory press "RESET" key to "START" reset process.

e.g RESET TRIP 1?

Press "RESET" key again to complete reset process.

e.g TRIP 1 0.00Ha

To change current Trip Memory press UP or DOWN key to change current trip number on display.

e.g TRIP 2 0.00Ha

**NOTE :** Trip records can be viewed or reactivated by using the UP and DOWN keys to change the current trip memory.  
Whichever trip number is displayed will be active when working.

## LOAD AREA

Load area is a separate area meter that can be reset after every bin refill to check coverage rates.

Press TRIP AREA key again to display LOAD AREA.

e.g LOAD 14.5 Ha

To reset Load Area press RESET key once to instantly reset load area total.

e.g LOAD 0.00 Ha

## LOAD ALARM

A LOAD AREA alarm point may be set to alert the operator when a bin should be empty after completing a set area. e.g. The seeder box will have one round left at 26.0 Ha. This can be useful with small seeds in a third bin where the quantity of product is insufficient to cover the normal Low Bin Sensor.

To set Load Alarm press TRIP AREA key again to display LOAD ALARM.

e.g 

Use UP and DOWN keys to set the desired load area alarm point.

e.g 

To start Load Alarm press TRIP AREA key to select LOAD AREA then RESET load area total after refilling bin / tank.

To cancel Load Alarm press TRIP AREA key to select LOAD ALARM then RESET load alarm to zero.

**NOTE :** RUN / HOLD key or remote RUN / HOLD will start / stop trip area and load area meters to maintain correct totals.

## 2.8 TIMER KEY

The "TIMER" key allows display of the ELAPSED TIME of machine operation.

The ELAPSED timer can be RESET to zero at any point. The "RUN / HOLD" key will STOP / START the elapsed timer.

Press the "TIMER" key to display the elapsed timer.

eg 

To reset Elapsed Timer press the "RESET" key.

## 2.9 FUNCTION KEY

Press the function key to step through the various monitored airseeder functions.

### **MONITORING FUNCTIONS**

The 2200 Surveillance monitors 3 Drive Shafts, 3 Bin levels, Fan Speed and Air pressure.

Pressing the "FUNCTION" key will allow you to view the current status of each of these inputs.

e.g

BINS	OK
SHAFT 1	15 RPM
SHAFT 2	18 RPM
SHAFT 3	8 RPM
AIR	9.5 Kpa
FAN	2500 RPM

### **BINS LEVELS:**

When the Function key is pressed you can display the status of all 2 or 3 (if used) Bin sensors, which are connected together on the same input.

eg 

BINS	OK
------	----

 = Material covers ALL Bin Sensors

or 

BINS	LO
------	----

 = At least one Bin Level is Low

Whenever the Level changes from OK to LO an audible alarm will repeat at 45 second intervals to remind the operator.

The Alarm will sound when any one of the sensors go LOW. You are required to physically check each of the bins to find out which one has emptied.

**SHAFT MONITORING:**

Shaft 1, Shaft 2 or Shaft 3 (if used) RPM can be displayed at any time by pressing the Function key.

eg 

If the RPM falls outside the HI/LO Alarm Point the display will automatically switch to display the Shaft that has the problem and the audible Alarm will activate at 5 second intervals.

eg 

If the Shaft stops, the Alarm will continue and display Shaft Stopped.

eg 

NOTE: Shafts operating at less than 10 RPM will take 6 - 60 seconds to activate an alarm after stopping.

**AIR PRESSURE**

The pressure sensor gives a reading between 0 - 25 Kpa.

e.g 

When the pressure drops falls outside the HI/LO Alarm points set in Calibration the display will instantly switch to Pressure Readout and an Audible alarm will repeat at 5 second intervals.

NOTE : A residual reading of 1 - 2 Kpa when no pressure present is normal.

**FAN MONITORING:**

Fan Speed can be displayed at any time.

eg 

If the Fan RPM falls outside the HI/LO Alarm point the Display will instantly switch to Fan readout and an audible Alarm will repeat at 5 second intervals.

eg 

If the Fan Stops, then the display will indicate Fan Stopped.

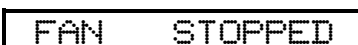
eg 

## 2.10 TEST KEY

The "TEST" key can be used to check that the various sensors are responding properly.

### **TEST FUNCTIONS**

Press the "TEST" key to step through the various sensor Test screens

eg

TEST WHEEL	0
SHAFT 1	0
SHAFT 2	0
SHAFT 3	0
AIR	1500 OHMS
TEST FAN	0
BIN LEVELS	HI

### **BIN(S) TEST**

Select Bins Test on display

LO = At least one sensor Uncovered (Red Lights at sensor ON)

HI = All Sensors Covered (Red Lights at sensors OFF)

### **SHAFT TEST**

Select Shaft No. 1, 2 or 3 to be tested

eg

SHAFT 1	0
---------	---

Monitor should beep and count the pulse each time the magnet sweeps past the sensor.

### **AIR TEST**

Selection of "AIR TEST" on the display will show the resistance(ohms) being produced by the sensor at various pressures. When full pressure is being produced (approx 25KPA) the display will show approximately 1500 OHMS.

eg

AIR	1500 OHMS
-----	-----------

When no pressure is present the test will show approximately 25 OHMS.

### **WHEEL TEST**

Select "WHEEL TEST" on display

eg

TEST	WHEEL
------	-------

The monitor should "Beep" and count for each rotation of the main Drive Shaft.

## 3.0 CALIBRATION

### 3.1 GENERAL INFORMATION

User configurable factors such as machine WIDTH, WHEEL and ALARM Points must be checked or set before operation. Factory recommended alarm points and wheel size settings are set as part of the Default setup.

The "CAL" key (Calibration) key is used to step through the various settings.

eg 

WIDTH	15.0M
-------	-------

Use the UP/DOWN arrow keys to change a setting or press "CAL" again to step to the next choice.

When you use the UP / DOWN arrow keys you can change the numbers slowly with repeated key presses or quickly by holding the key for a while.

The "RESET" key can be used to instantly zero any calibration setting. If you wish to step BACK through to a previous "CAL" option you must escape out of Calibration mode by pressing any normal function key then start again.

### 3.2 CALIBRATION WARNING

The SURVEILLANCE MONITOR has a unique protection system that compares and checks all your calibration settings to warn if any calibration factor becomes corrupted (changes value without your knowledge).

This is not a regular occurrence, but could be caused in a 'noisy' electrical environment e.g. An old petrol truck with wire ignition leads or faulty alternator.

When a corruption is detected, the monitor will beep continuously and the readout will display CHECK CAL warning.

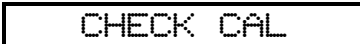
Eg 

Press the "CAL" key and check all calibration factors.

### 3.3 MEMORY BACK-UP

An inbuilt memory backup system will hold all calibrations and accumulated totals in memory when the power is switched off.

Memory will last for at least 3 months after disconnection from the 12 Volt DC. Power Source.

### 3.4 CALIBRATION SETTING

Press "CAL" key to step through implement WIDTH, WHEEL size and ALARM point Calibration options.

Factory recommended Default values are shown for Wheel and Alarm Calibrations.

#### **PROCEDURE**

Press "CAL" key to display implement "WIDTH"

Eg 

WIDTH	8.50M
-------	-------

Use UP/DOWN keys to set correct implement Width, press CAL to proceed.

Eg 

WHEEL	Ø.675M
-------	--------

 See 3.5 for Measurement Procedure

Use UP/DOWN keys to set WHEEL factor, press CAL to proceed.

Eg 

S1	LOALM	5
----	-------	---

 Shaft 1 Low Alarm point

Use UP/DOWN to set Low Alarm or set zero for No Alarm, press CAL to proceed.

Eg 

S1	HIALM	100
----	-------	-----

 Shaft 1 High Alarm point

Repeat procedure for all Alarm points.

S2	LOALM	5
----	-------	---

 Shaft 2 Low Alarm point

S2	HIALM	100
----	-------	-----

 Shaft 2 High Alarm point

(if used) 

S3	LOALM	5
----	-------	---

 Shaft 3 Low Alarm point

(if used) 

S3	HIALM	100
----	-------	-----

 Shaft 3 High Alarm point

Eg 

KPA	LOALM	Ø
-----	-------	---

 Pressure Low Alarm point

KPA	HIALM	Ø
-----	-------	---

 Pressure High Alarm point



**SHAFT LOW ALARM AT OR BELOW 5 RPM**

1. The display will show the following if the SHAFT LOW ALARM point is set at or below 5 RPM and the shaft speed is below the SHAFT LOW ALARM point :-

Eg SHAFT 1 STOPPED

The display will not show a SHAFT LOW ALARM.

2. To monitor shaft speeds below 5 RPM it is necessary to set the SHAFT LOW ALARM point to less than 5 RPM.

eg: With the SHAFT 1 LOW ALARM point set to 2 RPM, the Shaft 1 RPM may be displayed at any time by pressing the FUNCTION key.

Eg SHAFT 1 3 RPM

NOTE: KPA Alarm points are optional and will be governed by operating pressure depending on Fan Speed, and Material Rates and outlets.

FAN SLOW 2500

Fan Low Alarm point

FAN FAST 4600

Fan High Alarm point

R/HOLD ACTIVE OFF

Sets Hold Function when clutch 'OFF'

Press "CAL" key again to escape to normal operation.

### 3.5 WHEEL CALIBRATION

The wheel factor is a measurement of distance travelled between pulses from the Area sensor fitted to the drive shaft.

The factory default is 0.675M, however this should be checked.

#### **WHEEL CALCULATION PROCEDURE**

1. Measurement procedure must be performed in the field, not on a tarmac (recheck measurement when moving from hard to soft conditions).
2. Switch monitor ON and press TEST key to display TEST WHEEL counter.

Eg TEST WHEEL 0

3. Creep vehicle forward and watch the counter increment on every sensor pulse. Stop exactly on a pulse, then press RESET key to bring TEST WHEEL counter back to zero.
4. Peg ground at bottom centre of any wheel as a starting reference point for measurement.
5. Drive forward for approximately 25 metres or more and stop exactly on a pulse update.

Eg TEST WHEEL 14

6. Now measure the exact distance travelled and divide the pulses counted into the distance covered.

e.g. Distance 9.45 metres ÷ 14 pulses = 0.675 M / PULSE

7. Now press CAL key to display WHEEL calibration and use UP / DOWN keys to enter the correct wheel factor.

eg WHEEL 0.675M

## 4.0 TROUBLESHOOTING

PROBLEM	POSSIBLE CAUSE / REMEDY
1. NO POWER TO MONITOR WHEN ON / OFF KEY PRESSED	<p>a) If No Power to both monitors check fuse at battery end of Power cable 10 Amp maximum. Check fuse holder for corrosion.</p> <p>If fault with monitor, check monitor fuse. Replace fuse with 2 AMP FUSE only. If fuse blows immediately, disconnect Red wire Pin 8 at monitor Green plug.</p> <p>If fuse still blows, monitor faulty, otherwise fault in loom.</p> <p>b) Test voltage is 12 - 13.8V dc from battery.</p> <p>c) Check that RED wire is to +ve Pin 11 and BLACK wire is to -ve Pin 10.</p> <p>d) Check that no other electrical device is connected to the same power cable.</p> <p>e) Unable to locate fault - Contact nearest Dealer or Authorised Service Agent.</p>
2. LCD DISPLAY DROPS OUT OR GREY SQUARES APPEAR ON HALF THE READOUT.	<p>a) If display rectifies when engine running this indicates battery in poor condition.</p> <p>b) If problem persists when engine running, then voltage supply is low or low current is problem due to poor connection at battery, corroded inline fuse holder in power cable, or other equipment connected to power cable.</p> <p>c) Clean battery terminals and power cable connections.</p> <p>d) Make sure power cable is direct to battery terminals.</p>
3. "CHECK CAL" ON DISPLAY - INDICATES CALIBRATION FACTORS LOST FROM MEMORY.	<p>a) See Calibration warning instructions Section 3.3 in this manual.</p> <p>b) If problem occurs regularly, then it is probably caused by outside interference. See "Interference Causes and Remedies" Section 5.0</p> <p>c) Alternatively, CHECK CAL will be caused by failure of memory backup chip. In this case all calibrations will be lost from memory whenever the power switch is turned "OFF". See section 3.4 this manual.</p>
4. SPEED READOUT TOO FAST OR TOO SLOW	<p>a) Re check "WHEEL" Calibration is measured correctly and entered in Metres eg 2.445 metres.</p>

## TROUBLESHOOTING 2200 SURVEILLANCE V2.03 GASON

PROBLEM	POSSIBLE CAUSE / REMEDY
5. SPEED READOUT UNSTABLE OR ZERO	<p>a) Make sure Main Clutch is 'ON' and driving.</p> <p>b) Check Wheel Factor is set to 0.675M or thereabouts.</p> <p>c) Check Shaft Magnet on Main Drive is within 15MM 1/2" of sensor when turning</p> <p>d) Check Green 12 way plug at rear of Monitor is firmly inserted. Check Breakaways at rear of Tractor &amp; at Implement for dirty or broken pin connections, check connection of Area sensor on Main Drive shaft.</p> <p>e) Press TEST key to display WHEEL TEST, then disconnect AREA sensor &amp; use long nose pliers or a piece of wire to short out across pins of Loom Plug.</p> <p>If Monitor Beeps &amp; Counts, then sensor at fault. If No response then, possible wiring fault.</p> <p>Repeat short out Test at rear of monitor Pin 6 &amp; Pin 9. If No response, fault with monitor, See Dealer or Service agent for help.</p>
6. TOTAL AND TRIP AREA INCORRECT	<p>a) Check SPEED readout is correct and steady - if not, this will affect the area totals. See Troubleshooting Section 5</p> <p>b) Check Wheel &amp; Width calibration factors</p> <p>c) Is the machine overlapping or over counting headlands.</p> <p>d) Is the Run/Hold functional - See calibration 3.5</p>
7. TOTAL AND TRIP AREA WON'T RECORD	<p>a) Check that SPEED readout is working. If not see Trouble shooting Section 5.</p> <p>b) Press RUN/HOLD key to make certain monitor is "OFF HOLD".</p> <p>c) If Remote RUN / HOLD is used, then switch implement on and monitor should go "OFF HOLD". If reverse occurs, then switch to CAL mode and reverse Run / Hold active OFF / ON calibration.</p>

## TROUBLESHOOTING 2200 SURVEILLANCE V2.03 GASON

PROBLEM	POSSIBLE CAUSE / REMEDY
8. SHAFT 1, 2 OR 3 RPM WON'T COUNT	<ul style="list-style-type: none"> <li>a) Readout may take up to 30 seconds to start readout if Shaft very slow.</li> <li>b) Press TEST key to display relevant Shaft Test.</li> <li>c) Make sure magnet and sensor are close enough</li> <li>d) Disconnect Shaft Sensor and use a pair of long nose pliers to short out across the connector plug from the Wiring Loom</li> <li>e) If monitor 'Beeps' replace sensor. If No response repeat shorting Test at all Breakaway points back to monitor.</li> <li>f) If No response directly into monitor, return monitor for service.</li> </ul>
9. AREA & SHAFT SENSOR TEST PROCEDURE	<p><b><u>DO NOT</u> TEST WHEEL SENSOR WITH A TEST LIGHT, USE A MULTIMETER ONLY.</b></p> <ul style="list-style-type: none"> <li>a) Disconnect Wheel Sensor from cable.</li> <li>b) Switch Multimeter "ON" and select "OHMS" scale.</li> <li>c) Touch test probes together and meter needle should swing to right of scale indicating "0" OHMS resistance. (If digital meter display - should read zero).</li> <li>d) Move Wheel sensor magnet away from sensor and connect test probes to Wheel sensor pins. If meter goes to zero, then sensor is short circuit (faulty). If the meter stays to the left of scale, hold wheel magnet in front of sensor, meter should go straight to zero. If meter fails to change, then sensor is open circuit. (faulty)</li> </ul>
10 BIN SENSOR FAILS TO ALARM (1830/50 ONLY)	<ul style="list-style-type: none"> <li>a) Check Red light at rear of sensor, should glow bright when uncovered and glow dull when covered.</li> <li>b) If no light , check voltage between pin B &amp; C at sensor connection should be 12 Volts D.C.</li> <li>c) Press TEST key to select TEST BIN 1 or TEST BIN 2 mode.</li> <li>d) Place hand over end of Bin Sensor - should display HI when covered and LO when uncovered.</li> <li>e) If NO response, Disconnect Bin Sensor from Airseeder loom and tests should read HI.</li> <li>f) If test stays LO then look for short circuit in wiring or disconnect relevant sensor wire at monitor. If still no response fault with monitor.</li> <li>g) If test stays HI, then make a short circuit between Pins A and B of Bin Sensor wiring Loom connector plug and test should read LO.</li> <li>h) If No response and other sensors work then Wiring Loom is open circuit Pin A. Back to monitor.</li> </ul>

## TROUBLESHOOTING 2200 SURVEILLANCE V2.03 GASON

PROBLEM	POSSIBLE CAUSE / REMEDY	
11 BIN SENSORS FAIL TO ALARM (1880 ONLY)	a) b) c) d) e) f)  g)	<p>All sensors are daisy chained together on the same input, therefore all Bin Sensors must be covered, then uncover any <u>one</u> sensor to activate Alarm.</p> <p>Check Red light at rear of each Bin Sensor should glow brightly when uncovered &amp; dull when covered.</p> <p>If No light, check voltage between pin B &amp; C of connector to sensor, should be 12V D.C. If voltage weak, clean implement Breakaways &amp; check for damaged or squashed pins.</p> <p>If voltage OK, replace sensor.</p> <p>If all sensors fail to activate &amp; alarm, then fault with loom or monitor.</p> <p>Press TEST key to display BINS TEST &amp; unplug all bin sensors, should read HI. If still LO then loom is possibly short circuit.</p> <p>Disconnect wire from Pin 7 of monitor &amp; if monitor changes to HI then fault with loom. If Monitor stays LO then fault with Monitor.</p> <p>If Test reads HI with all Bin Sensors disconnected, then short circuit between Pins A &amp; B of any Bin Sensor loom plug &amp; test should go LO</p>
12 PRESSURE SENSOR NOT READING OR INACCURATE	a) b) c)	<p>If reading stays at zero, disconnect pressure sensor wiring &amp; readout should go to 25KPA. If response OK, then fault with pressure sensor.</p> <p>If No response, check loom for short circuit, disconnect wire from Pin 4 of monitor &amp; if still zero then fault with monitor, otherwise loom at fault.</p> <p>If reading stays at 25KPA, then disconnect pressure sensor wiring at sensor end and short circuit between Pin A &amp; Pin B of connector. If Pressure readout drops to zero then loom OK, sensor at fault. If NO response then loom open circuit.</p>
13 PRESSURE OR SHAFT ALARM KEEPS ACTIVATING	a)  b)	<p>Watch Readout for fluctuation that may be cause by sensor fault, wiring fault or actual machine fault.</p> <p>Reprogram alarm points outside working range.</p>

## 5.0 INTERFERENCE AND REMEDIES

CAUSES	REMEDIES
Noisy wire ignition leads on petrol engine or pump motor.	Replace with Carbon leads. Fit suppressors to coil and distributor.
Faulty Alternator	Exchange it
Other electrical equipment running off monitor power cable	Run separate power cable DIRECT to 12V battery for Monitor.
Calibrations get corrupted when solenoids / clutch switched off.	Make sure Monitor has its own separate Power Cable direct to 12V Battery. Fit diode across solenoid coil / clutch to clamp spike. Run power cable Physically away from solenoid / clutch wiring.

## 6.0 SPECIFICATIONS

Supply voltage	+12V DC
Temp	20 - 70 °C
Humidity	Weatherproof
Fuse	1 Amp (M205 type)

## 7.0 CONTACT DETAILS

FARMSCAN  
6 SARICH WAY  
TECHNOLOGY PARK  
BENTLEY WA 6102

Tel : (08) 9470 1177  
Fax : (08) 9470 2855  
email : [service@farmscan.net.au](mailto:service@farmscan.net.au)





# GASON TRAILER LOOM 1830/1850

Part No: AC-2200GT/3

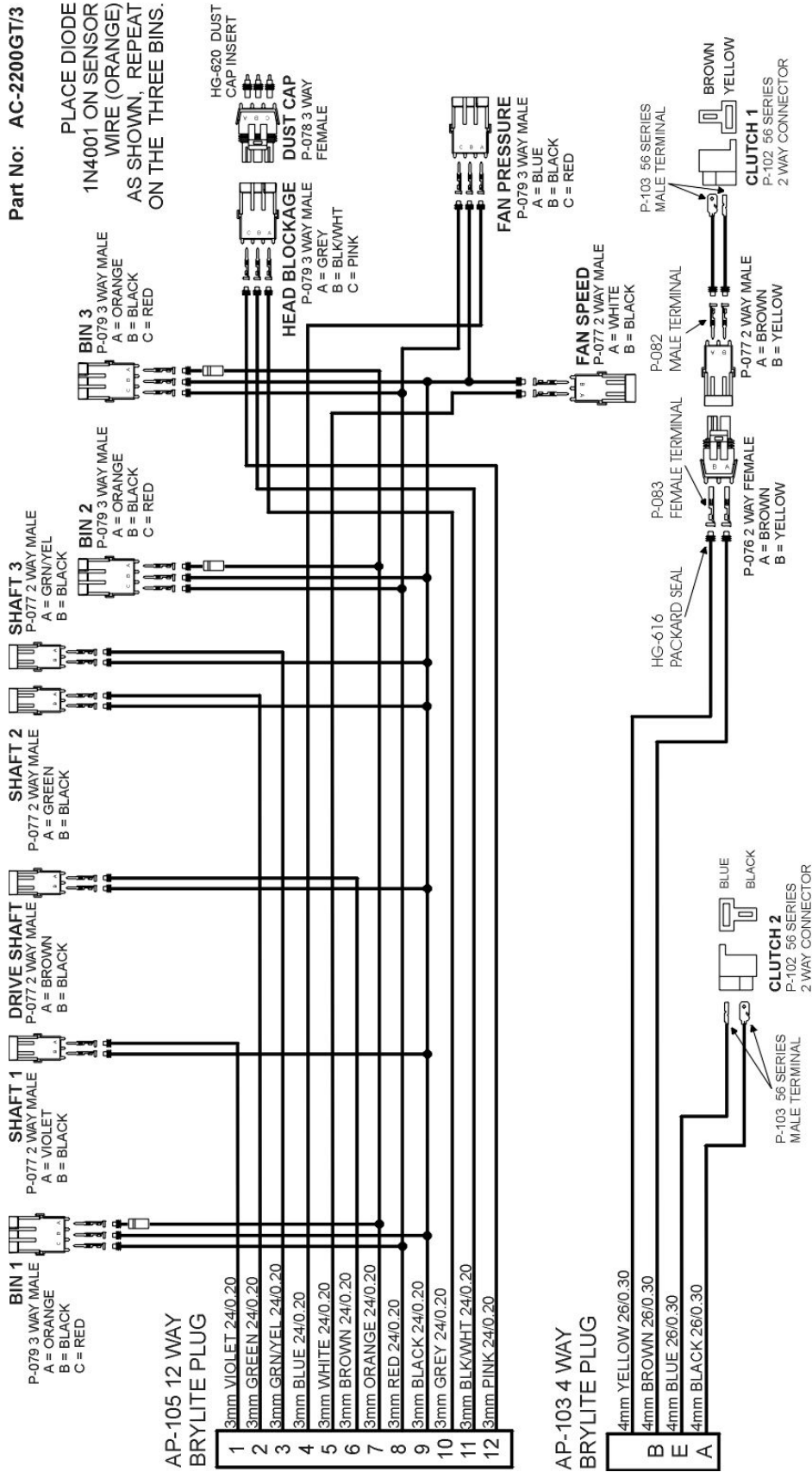

# GASON TRAILER LOOM 1880/2120

